

R5020

Hardware Manual



Version: 1.1.0

Date: August 12, 2025

Regulatory and Type Approval Information

Table 1: Toxic or Hazardous Substances or Elements with Defined Concentration Limits

Name of the Part	Hazardous Substances									
	(Pb)	(Hg)	(Cd)	(Cr(VI))	(PBB)	(PBDE)	(DEHP)	(BBP)	(DBP)	(DIBP)
Metal parts	X ^{1,2}	o	o	o	-	-	-	-	-	-
Circuit modules	o	o	o	o	o	o	o	o	o	o
Cables and cable assemblies	o	o	o	o	o	o	o	o	o	o
Plastic and polymeric parts	o	o	o	o	o	o	o	o	o	o

o:
Indicates that this toxic or hazardous substance contained in all of the homogeneous materials for this part is below the limit requirement in RoHS2.0.

X:
Indicates that this toxic or hazardous substance contained in at least one of the homogeneous materials for this part *might exceed* the limit requirement in RoHS2.0.

-:
Indicates that it does not contain the toxic or hazardous substance.

Note: Excessive lead can be exempted.

1.Copper alloy containing up to 4 % lead by weight (RoHS Exemption 6(c)).

2.Electrical and electronic components containing lead in a glass or ceramic other than dielectric ceramic in capacitors, e.g. piezoelectronic devices, or in a glass or ceramic matrix compound (ROHS Exemption 7(c)- I)

Radio Specifications for Europe

Model: R5020-5G-A30EU-A, R5020-5G-A30EU-B

RF technologies	3G, 4G, 5G, GNSS, Wi-Fi
Cellular Frequency*	3G: WCDMA: B1/B5/B8 4G: LTE FDD: B1/B3/B5/B7/B8/B20/B28/B32 LTE TDD: B38/B40/B41/B42/B43 5G NR: NSA/SA: n1/n3/n5/n7/n8/n20/n28/n38/n40/n41/n71/n75/n76/n77/n78
Wi-Fi Frequency	2.4 GHz: 2.412 - 2.472 GHz 5 GHz: 5.15 - 5.825 GHz
Max RF power	27 dBm ±2 dB@5G, 24 dBm ±2 dB@4G, 24 dBm +1/-3 dB@3G, 18 dBm ±2 dB@2.4G Wi-Fi, 20 dBm ±2dB@5G Wi-Fi

* *May vary on difference models.*

Note: The 5150 to 5350 MHz frequency range is restricted to indoor use only in.

電波法の規定により 5GHz 帯は屋内使用に限ります。

	AT	BE	BG	CH	CY	CZ	DE	DK
	EE	EL	ES	FI	FR	HR	HU	IE
	IS	IT	LI	LT	LU	LV	MT	NL
	NO	PL	PT	RO	SE	SI	SK	UK UK(NI)

Caution: The user is cautioned that changes or modifications not expressly approved by the party responsible for compliance could void the user's authority to operate the equipment.

This device contains licence-exempt transmitter(s)/receiver(s) that comply with Innovation, Science and Economic Development Canada’s licence-exempt RSS(s) and Part 15 of the FCC Rules. Operation is subject to the following two conditions:

- (1) This device may not cause interference.
- (2) This device must accept any interference, including interference that may cause undesired operation of the device.

L'émetteur/récepteur exempt de licence contenu dans le présent appareil est conforme aux CNR d'Innovation, Sciences et Développement économique Canada applicables aux appareils radio exempts de licence. L'exploitation est autorisée aux deux conditions suivantes :

- (1) L'appareil ne doit pas produire de brouillage;
- (2) L'appareil doit accepter tout brouillage radioélectrique subi, même si le brouillage est susceptible d'en compromettre le fonctionnement.

Note: This equipment has been tested and found to comply with the limits for a Class B digital device, pursuant to Part 15 of the FCC Rules. These limits are designed to provide reasonable protection against harmful interference in a residential installation. This equipment generates, uses and can radiate radio frequency energy and, if not installed and used in accordance with the instructions, may cause harmful interference to radio communications. However, there is no guarantee that interference will not occur in a particular installation.

If this equipment does cause harmful interference to radio or television reception, which can be determined by turning the equipment off and on, the user is encouraged to try to correct the interference by one or more of the following measures:

- Reorient or relocate the receiving antenna.
- Increase the separation between the equipment and receiver.
- Connect the equipment into an outlet on a circuit different from that to which the receiver is connected.
- Consult the dealer or an experienced radio/TV technician for help.

FCC& IC Radiation Exposure Statement

This equipment complies with FCC and Canada radiation exposure limits set forth for an uncontrolled environment. This equipment should be installed and operated with a minimum distance of 20cm between the radiator and your body.

This transmitter must not be co-located or operating in conjunction with any other antenna or transmitter.

Déclaration d'IC sur l'exposition aux radiations

Cet équipement est conforme aux limites d'exposition aux radiations définies par le Canada pour des environnements non contrôlés. Cet équipement doit être installé et utilisé à une distance minimum de 20 cm entre l'antenne et votre corps.

Cet émetteur ne doit pas être installé au même endroit ni utilisé avec une autre antenne ou un autre émetteur.

Simplified EU & UK Declaration of Conformity

We, Guangzhou Robustel Co., Ltd. are located at 501, Building #2, 63 Yongan Road, Huangpu District, Guangzhou, China, declare that this radio equipment complies with EU Radio Equipment Directive (RED) 2014/53/EU, Low Voltage Directive (LVD) 2014/35/EU, EMC Directive 2014/30/EU, UK Radio Equipment Regulations 2017, EMC Regulations 2016, Electrical Equipment (Safety) Regulations 2016. The full text of the EU& UK DoC is available at the following internet address:

www.robustel.com/certifications/

Safety Information

General

- The router generates radio frequency (RF) power. When using the router, care must be taken on safety issues related to RF interference as well as regulations of RF equipment.
- Do not use your router in aircraft, hospitals, petrol stations or in places where using cellular products is prohibited.
- Be sure that the router will not be interfering with nearby equipment. For example: pacemakers or medical equipment. The antenna of the router should be away from computers, office equipment, home appliance, etc.
- An external antenna must be connected to the router for proper operation. Only uses approved antenna with the router. Please contact authorized distributor on finding an approved antenna.

RF Exposure

- This device meets the official requirements for exposure to radio waves. This device is designed and manufactured not to exceed the emission limits for exposure to radio frequency (RF) energy set by authorized agencies.
- The device must be used with a minimum separation of 20 cm from a person's body to ensure compliance with RF exposure guidelines. Failure to observe these instructions could result in your RF exposure exceeding the applicable limits.

Note: Some airlines may permit the use of cellular phones while the aircraft is on the ground and the door is open. Router may be used at this time.



The symbol indicates that the product should not be mixed with general household waste but must be sent to separate collection facilities for recovery and recycling.



The symbol indicates that the product meets the requirements of the applicable EU directives.



The symbol indicates that the product meets the requirements of the relevant UK legislation.

⚠ WARNING:

This product can expose you to chemicals including Lead, known to the State of California to cause cancer and birth defects or other reproductive harm. For more information go to www.P65Warnings.ca.gov.

Related download link

Find more product documents or tools at:

www.robustel.com/documentations/

Technical Support

Tel: 400-987-3791

Email: support@robustel.com

Web: www.robustel.com

Document History

Updates between document versions are cumulative. Therefore, the latest document version contains all updates made to previous versions.

Date	Document Version	Change Description
July 6, 2022	1.0.0	Initial release.
Nov. 22, 2022	1.0.1	Added declaration for product.
Jan. 29, 2023	1.0.2	Optimized description of pictures and text.
Jun. 15, 2023	1.0.3	1. Optimized the installation description of 4-in-1 antenna. 2. Updated ground screw pattern.
July 14, 2023	1.0.4	Modified declaration for product.
Sept. 26, 2023	1.0.5	Updated product information.
July 3, 2024	1.0.6	1. Added description of lead exemption. 2. Updated product information.
August 12, 2025	1.1.0	1. Updated the RF technologies and cellular frequency band. 2. Modified the Max RF power. 3. Updated the Wi-Fi indoor use statement.







		<ol style="list-style-type: none">4. Added GNSS antenna and Nano SIM adapter to the package checklist.5. Updated the back view in the panel layout.6. Added a size diagram of the Nano SIM card in the SIM card installation section.7. Revised the description for Antenna Installation.8. Updated all pictures related to the GNSS interface.9. Updated the description of the RSSI indicator.10. Updated the description and typical application of the DI/DO interface.
--	--	---

Overview

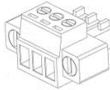
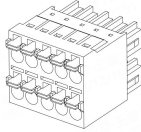
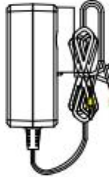
Robustel R5020 supports WCDMA 3G network, LTE 4G network, and NR 5G network to provide high-speed wireless network bandwidth for devices through wireless connection, and it has dual-SIM card backup to ensure stable wireless network connection.

Package Checklist

Before commencing installation ensure your package has the following components:

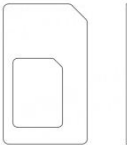
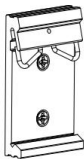
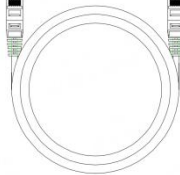
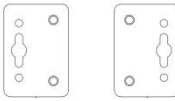
<p>Device</p> 	<p>3-PIN Terminal Block</p> 	<p>2x5-PIN Terminal Block</p> 	<p>Power Supply</p> 	<p>RCMS Card</p> 
<p>Quick Start Guide Card</p> 	<p>QC Card</p> 	<p>Cellular Antenna</p> 	<p>Wi-Fi Antenna</p> 	<p>GNSS Antenna</p> 
<p>Nano SIM Adapter</p> 	<p>35mm Din rail</p> 	<p>Ethernet Cable (Optional)</p> 	<p>Mounting Kit (Optional)</p> 	

Note: The accessories could be different on specific order.

Panel Layout (May Vary on Different Models)

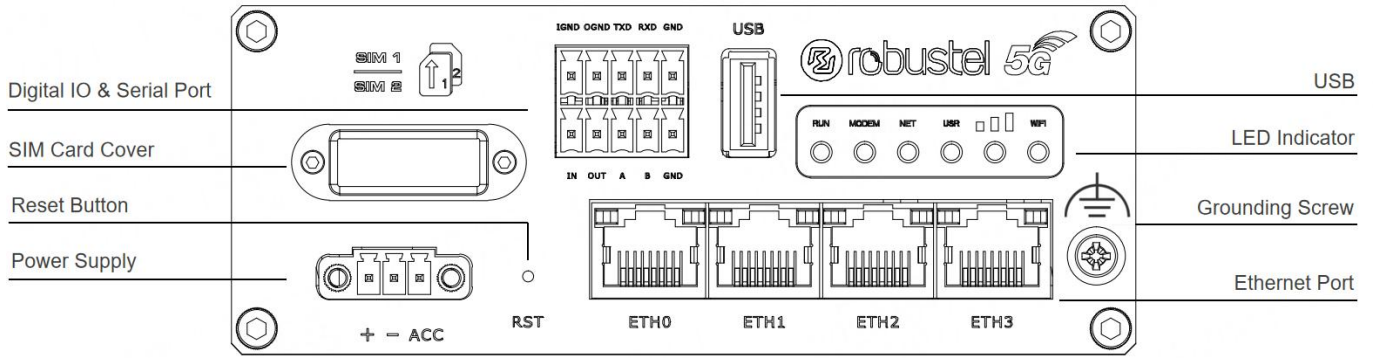

Front-View

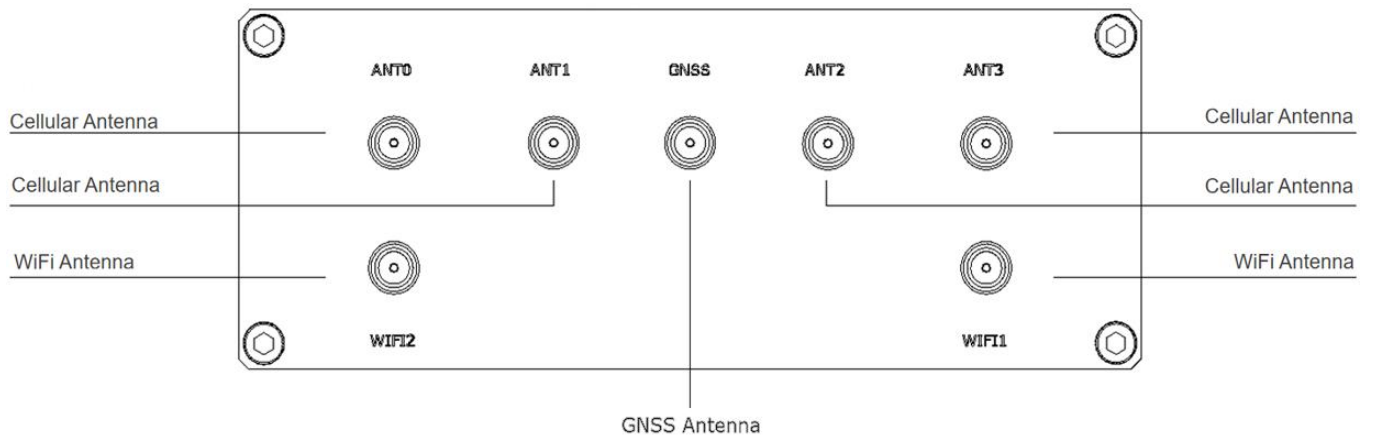

Back-View

Interface Descriptions

1. Power Supply. 3PIN 3.5mm pitch terminal block.

PIN	Description	Note
1	V+	Connect adapter or battery positive (red line)
2	V-	Connect adapter or battery negative (yellow line)
3	ACC (Optional)	Car ignition and flameout detection (green line) Note: when the car ignition and flameout detection function is not used, the ACC pin need to be connected to the V+ and cannot be left floating.

With ACC Function

With POE Function

Note:

- 1) ACC and POE function can only be selected one
- 2) The input voltage is 10 to 30V DC(With ignition sensing) or 9 to 36V DC(Without ignition sensing)

2. LED Indicator.

Name	Color	Status	Description
RUN	Green	On, solid	Router is powered on
		On, blinking	Router starts operating
		Off	Router is powered off
MODEM	Green	On, solid	Link connection is working
		On, blinking	Data is sent and received
		Off	Link connection is not working
NET	Green	On, solid	Connection to 5G network is established(5g signal is the best)
		On, blinking	Connection to Legacy network (4G or 3G) is established(3G signal difference / 4G signal medium)
		Off	Network is not joined or joining
	Yellow-Green	On, solid	5G network: Reference Signal Received Power ≥ -85 dBm (Strong signal) Non-5G network: Received Signal Strength Indication ≥ -71 dBm (Strong signal)
	Orange-Yellow	On, solid	5G network: Reference Signal Received Power -105 to -86 dBm (Moderate signal) Non-5G network: Received Signal Strength Indication -91 to -72 dBm (Moderate signal)
	Red	On, solid	5G network: Reference Signal Received Power ≤ -106 dBm (Weak signal) Non-5G network: Received Signal Strength Indication ≤ -92 dBm (Weak signal)
	--	Off	No signal
WiFi	Green	On, solid	Wi-Fi is enabled and working properly
		On, blinking	Data is sent and received
		Off	Wi-Fi is disabled or not working properly
USR	Green	User-defined LED. It can be used to indicate SIM card, OpenVPN, IPSec connection status, or status in self-developed applications. You can choose the display type of USR LED. For more details, please refer to RT123_SM_RobustOS Software Manual: Services > Advanced > System > System Settings > User LED Type.	

3. Reset Button.

Feature	Operation
Reboot	Press and hold the RST button for 2~ 5 seconds under the operating status.
Restore to default configuration	Press and hold the RST button for 5~10 seconds, the RUN LED starts blinking quickly, the router will restore to default configuration.
Restore to factory default settings	Once the operation of restoring default configuration is performed twice within one minute, the router will restore to factory default settings.

Note: The more details please refer to **RT123_SM_RobustOS Software Manual, 2.3 Factory Reset.**

- 4. Ethernet Ports.** There are four Ethernet ports on R5020, including ETH0 (Optional POE supported), ETH1, ETH2, ETH3. The ETH0 on the router can be configured as a WAN port, while ETH1, ETH2 and ETH3 can only be configured as a LAN port. By default, ETH1, ETH2 and ETH3 are lan0, and their IP are 192.168.0.1/255.255.255.0.

Ethernet LED Indicator	Status	Description
Link indicator (Yellow)	On, solid	Connection is established
	On, blinking	Data is being transferred
	Off	Connection is not established

5. Digital IO & Serial Port. 2x5PIN 3.5mm pitch terminal block, 1 set of DO, 1 set of DI, 1 x RS232 and 1 x RS485.
 The Digital Input (DI) interface is compatible with NPN or PNP type sensor signals and can be used for collecting switch signals. The Digital Output (DO) interface can drive loads up to 30V with a maximum current of 100mA.

PIN	DI/DO	RS232	RS485	Direction
1	IGND	--	--	--
2	OGND	--	--	--
3	--	TXD	--	Router → Device
4	--	RXD	--	Router ← Device
5	--	GND	--	--
6	IN	--	--	--
7	OUT	--	--	--
8	--	--	A	--
9	--	--	B	--
10	--	--	GND	--

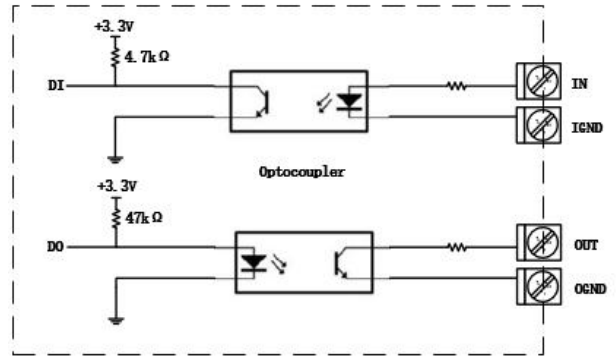

Internal diagram of DI&DO

Typical Application:

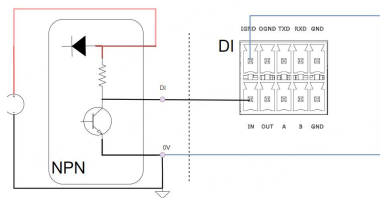

DI connected with NPN sensor

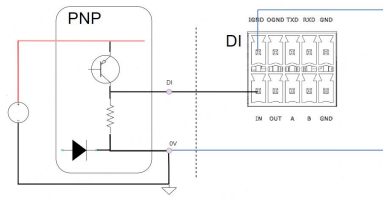

DI connected with PNP sensor

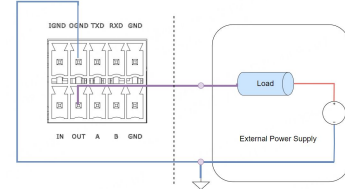

DO Driven connection

Note: The external power supply DC voltage range is 3V~30V.

6. USB Interface.

Feature	Operation
Firmware upgrade	USB interface is used for batch firmware upgrading, but cannot be used for sending or receiving data from slave devices which connected to it. You can insert a USB storage device into the router's USB interface, such as a U disk or a hard disk. If there have a supported configuration file or a router firmware in this USB storage device, the router will automatically update the configuration file or the firmware. For more details, please refer to <i>RT123_SM_RobustOS Software Manual</i> .

Hardware Installation

- SIM Card Installation.** Remove the SIM card cover to insert the SIM cards into the device, then screw up the cover.

***Note:** To ensure optimal performance and compatibility, it is recommended to use 2FF SIM cards that meet industrial-grade standards and feature an integrated design.

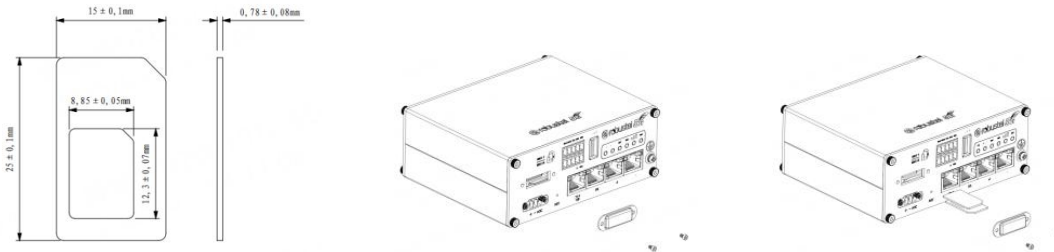

- Antenna Installation.** Rotate the antenna into the antenna connector accordingly.

① Cellular Antenna

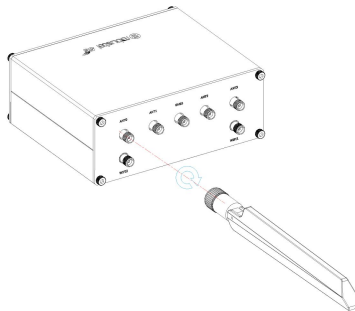

② GNSS Antenna

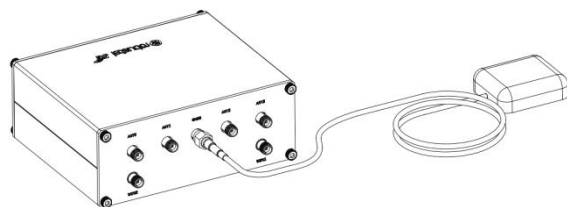

- Terminal Block Installation.** Insert the 2x5PIN terminal blocks into the interfaces connector, then can connect the devices or sensors to the gateway via corresponding interfaces.

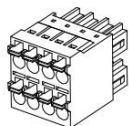

4. Mounting Kit installation.

① Wall-mounted Installation

Dimension diagram (unit:mm) :

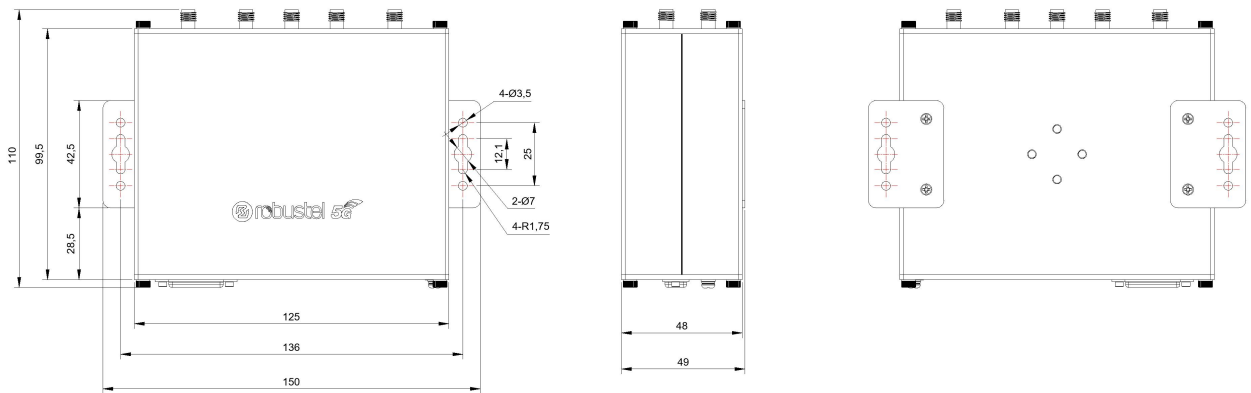

Installation method:

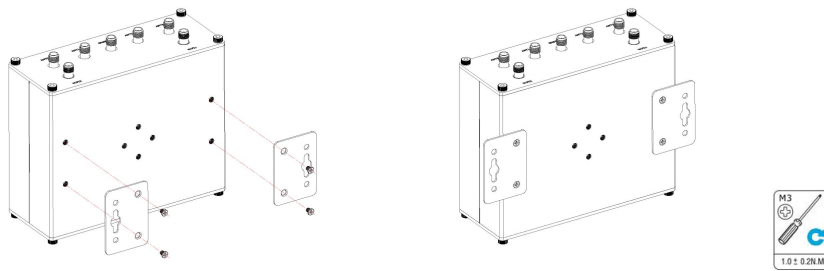

② 35mm DIN Rail Installation

Dimension diagram (unit:mm) :

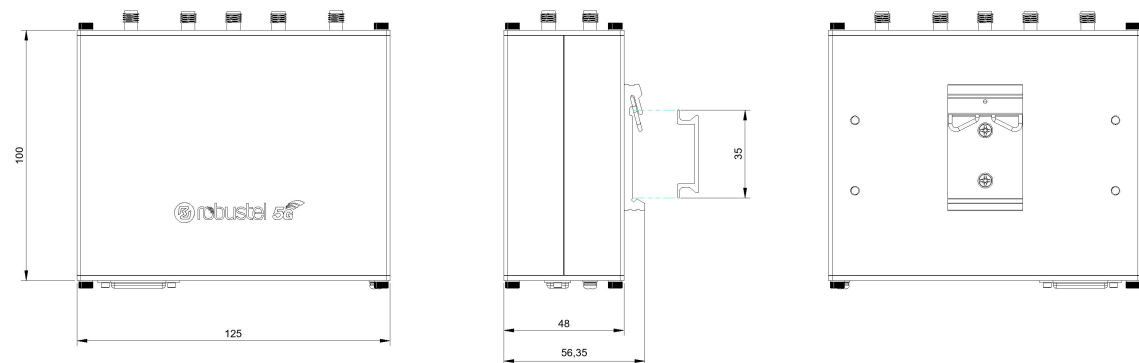

Installation method:

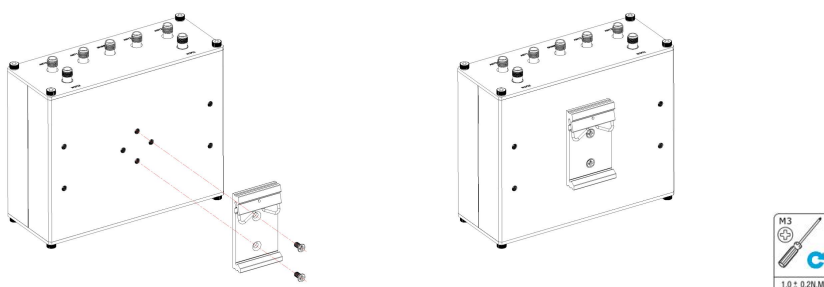

5. Grounding the Device. Grounding will help to prevent the noise effect due to electromagnetic interference (EMI). Connect the device to the site ground wire by the grounding screw before powering on.

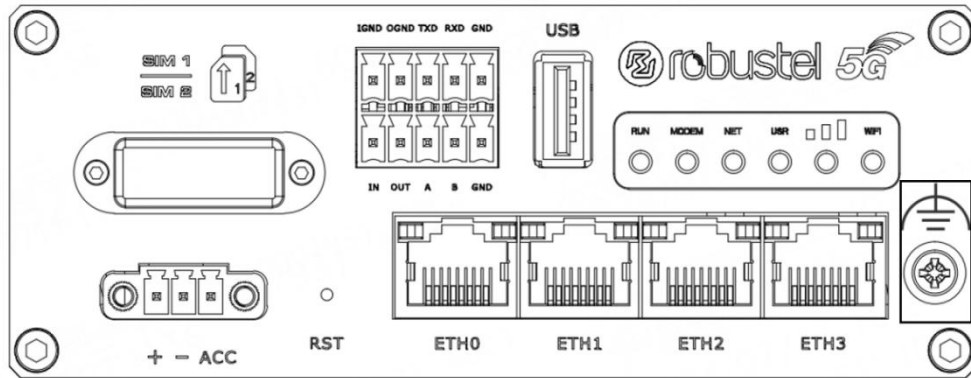

6. Power Supply installation. Insert the power supply cord into the corresponding terminal block if needed, then insert the terminal block into the power connector.

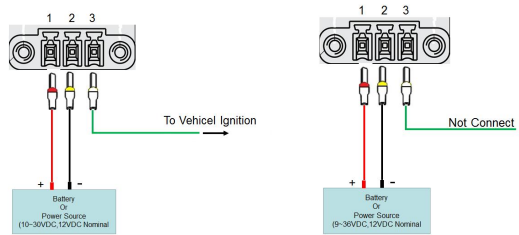

7. Connect the router to PC. Connect the Ethernet cable to any port labeled ETH0 to ETH3 on the bottom of the router, and connect the other end of the cable to your computer.

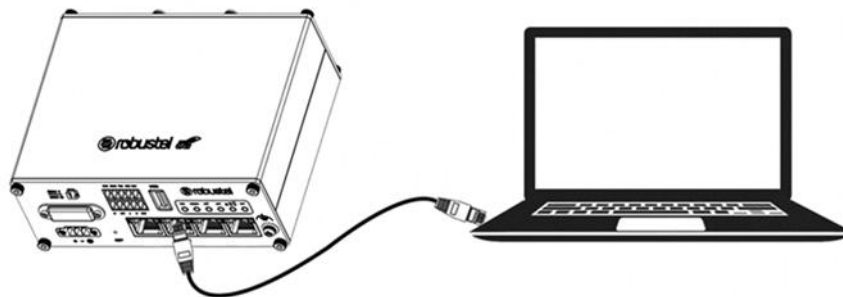

Login to the Device

1. Connect the router’s Ethernet port to a PC with a standard Ethernet cable.
2. Before logging in, manually configure the PC with a static IP address on the same subnet as the gateway address, click and configure "Use the following IP address".

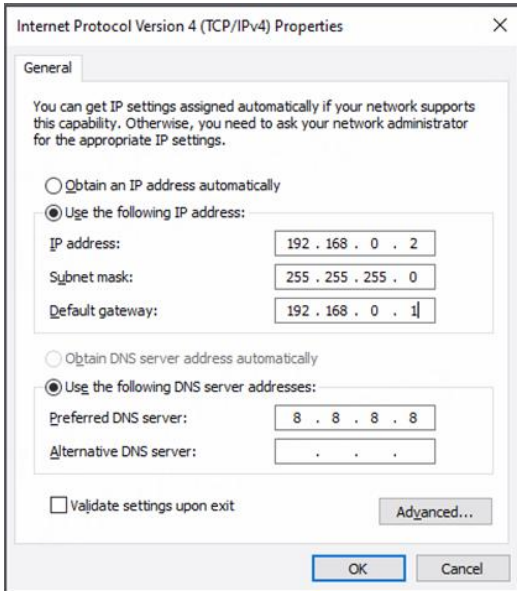

3. To enter the gateway's web interface, type <http://192.168.0.1> into the URL field of your Internet browser.
4. Use login information shown in the product label when prompted for authentication.



5. After logging in, the home page of the web interface is displayed, then you can view system information and perform configuration on the device.

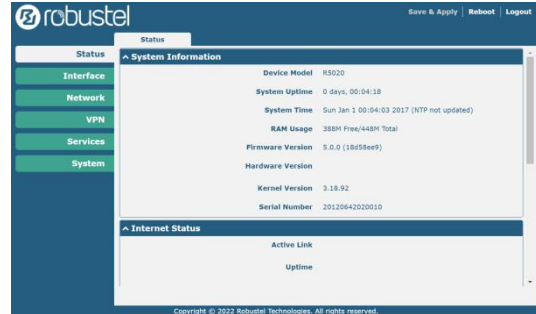

6. The automatic APN selection is ON by default, if need to specify your own APN, please go to the menu **Interface->Link Manager->Link Setting->WWAN Settings** to finish the specific setting.

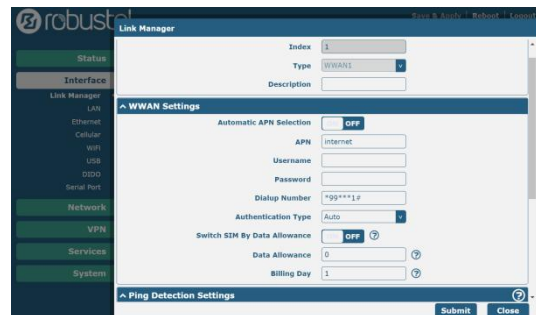

7. The more configuration details please refer to **RT123_SM_RobustOS Software Manual**.
(END)